

Public Policy and Politics: Compliance Tips for Your Nonprofit's Advocacy and Electoral Efforts

Tuesday, April 16, 2013
12:30 p.m. – 2:00 p.m. EDT

Venable LLP
Washington, DC

Moderator:

Jeff Tenenbaum, Esq., Venable LLP

Panelists:

Larry Norton, Esq., Venable LLP
Ron Jacobs, Esq., Venable LLP
Janice Ryan, Esq., Venable LLP

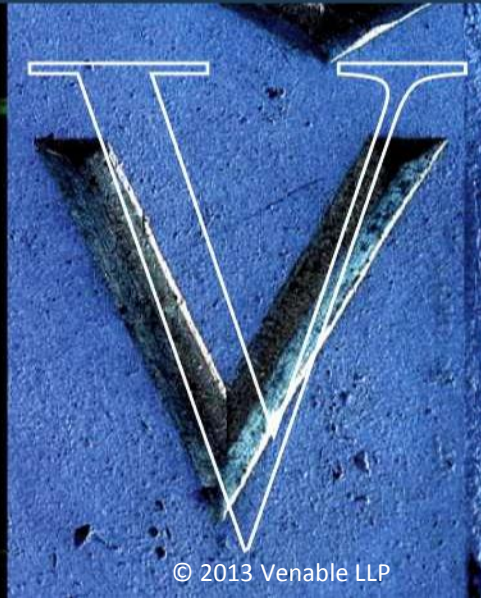
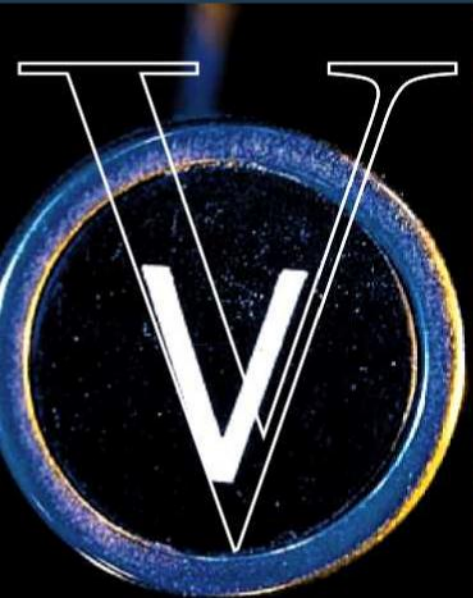

Upcoming Venable Nonprofit Legal Events

May 14, 2013 - [As Nonprofits Expand Their Global Reach, a Special Focus on Tax, Trademarks and the Foreign Corrupt Practices Act](#)

June 25, 2013 - Employee Leaves of Absence and Other Employee Accommodations under the Law: What Every Nonprofit Needs to Know (details coming soon)



Agenda

1. Growing Your PAC

2. Independent Expenditures

3. 501(c)(3) Election Issues

4. Lobbying Disclosure

5. Tax Issues

6. Hosting Events



VENABLE[®]_{LLP}

Political Action Committees



Why a PAC?

- **Corporations still prohibited from making contributions to candidates**
- **Corporations prohibited from facilitating contributions**
- ***Citizens United* did not change this**



Who funds a PAC?

Members

Executives
of
Association



PAC

Individual Membership Organization



Who are your members?

1. Satisfies requirements of organization
2. Affirmatively accepts
3. Relationship with organization



Relationship Prong

- Pays annual dues

OR

- Annual affirmation and participatory rights
 - ✓ Vote for board member
 - ✓ Vote for officers
 - ✓ Binding vote on policy
 - ✓ Approve budget



Who funds a PAC?

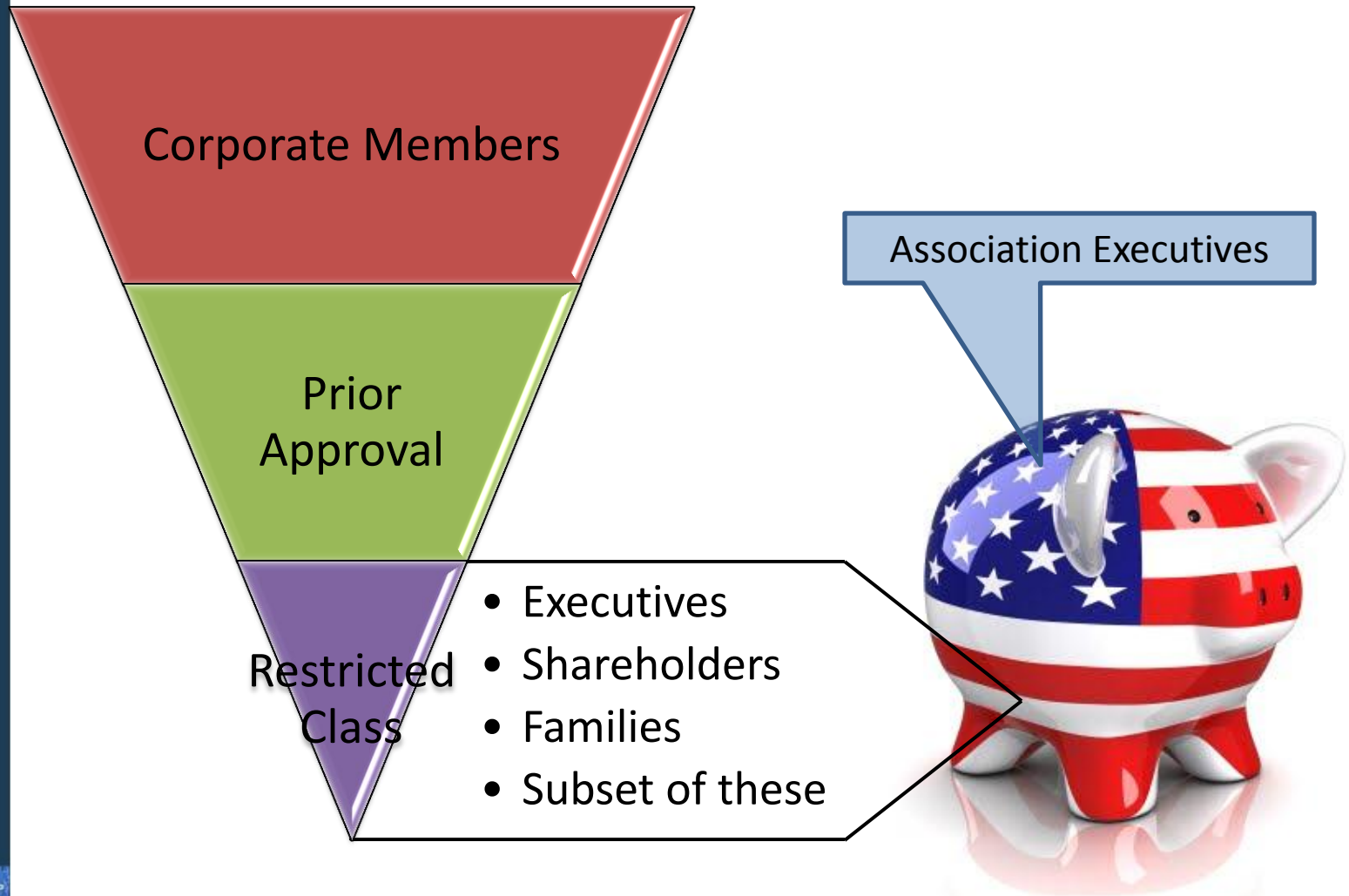

Corporate Membership Organization

Prior Approval

- **Written**
- **Signed for each year**
- **Only one association per year**



Successful Prior Approval

- **Simple**
- **Friendly**
- **Limited**
- **Explain the PAC**

Ask is not for money

Ask is approval to solicit



Invitations to Events Conundrum

- **If no prior approval, cannot invite to the event → solicitation**
- **Ask for prior approval to invite to event**



Events

7:30 pm PAC Reception, Ballroom

Invitation Only

[Click here to learn about the PAC or call...](#)



Tradeshows

Political Action Committee

- If no prior approval
→ Get approval
- If prior approval
→ Ask for \$\$

Don't ask for money
if no prior approval



What is a solicitation?

- **Explicit request for money**
- **Publicizes right to accept unsolicited contributions**
- **Provides information on how to contribute**
- **Encourages support**



What is a not a solicitation?

- **Announce the existence of PAC**
- **Explain legal rules**
- **Information about receipts**
- **Information about disbursements**



Making the Ask

- Association
- The PAC
- The member
- Payroll deduction permitted



PAC Administrative Costs

- Paid for by “connected organization”
- May accept donations from corporate members
 - “Administrative Fund”
 - Not for contributions to candidates



Incentives

- **Drawings for prizes**
- **Trinkets**
- **Entertainment other than food**

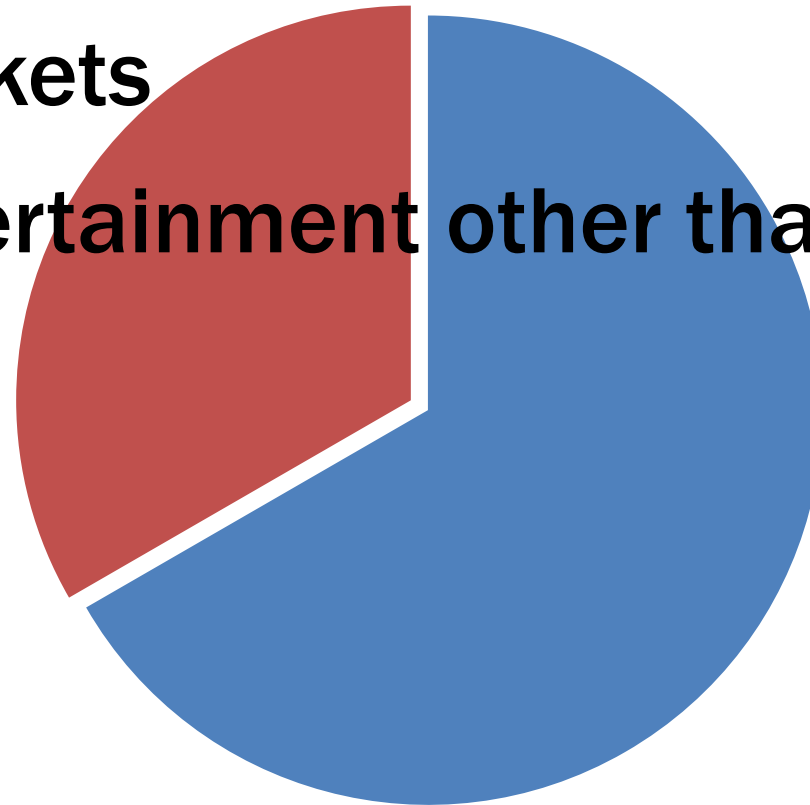

Using Federal PAC in States

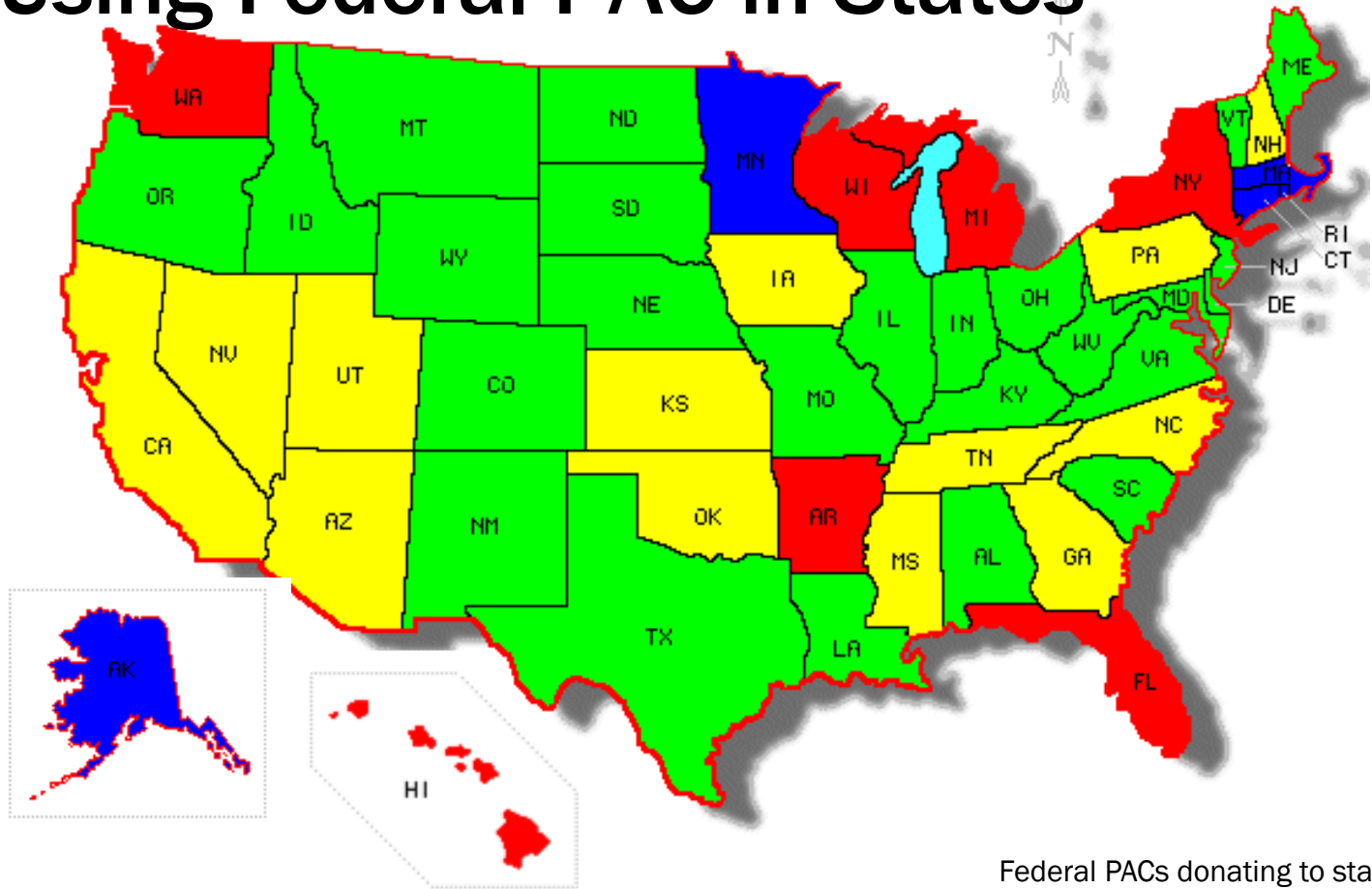

- Easy: Minimal reporting using FEC reports
- Moderate: Must register federal PAC with state and report on state schedule
- Difficult: In-state bank/treasurer requirements, or limits on solicitation (in-state employees only) limit federal PAC giving
- Very Difficult or Prohibited: Federal PAC generally may not give to state candidates

Federal PACs donating to state and local races must comply with state-specific limitations on contributions and expenditures.

Note: Subjective judgments involved in ranking states



Corporate Campaign Contributions

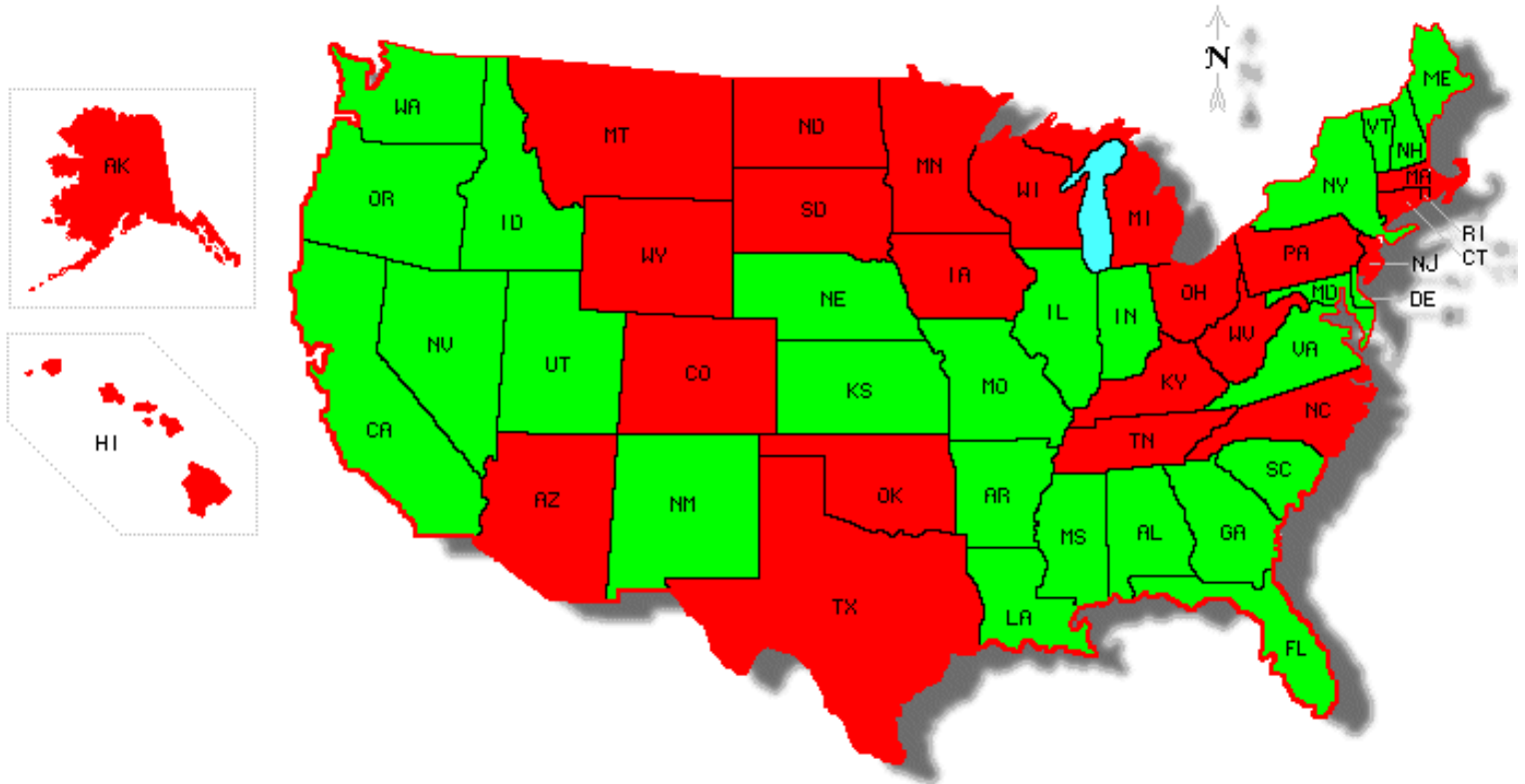

527(f) Tax

Net Investment
Income

Political
Expenditures

Tax

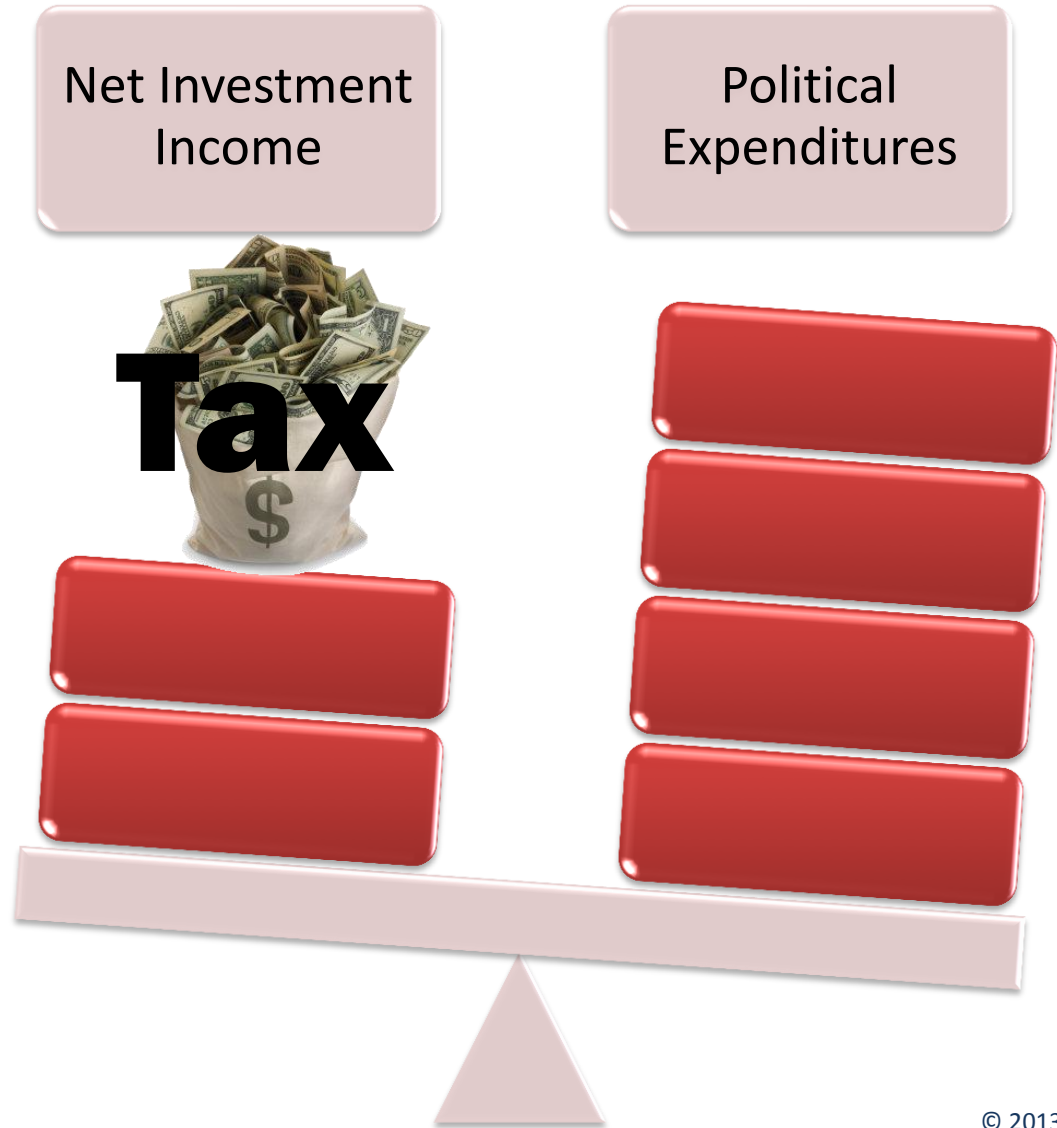

527(f) Tax

Net Investment
Income

Political
Expenditures



VENABLE[®]_{LLP}

Communicating with the Public

Range of Activities

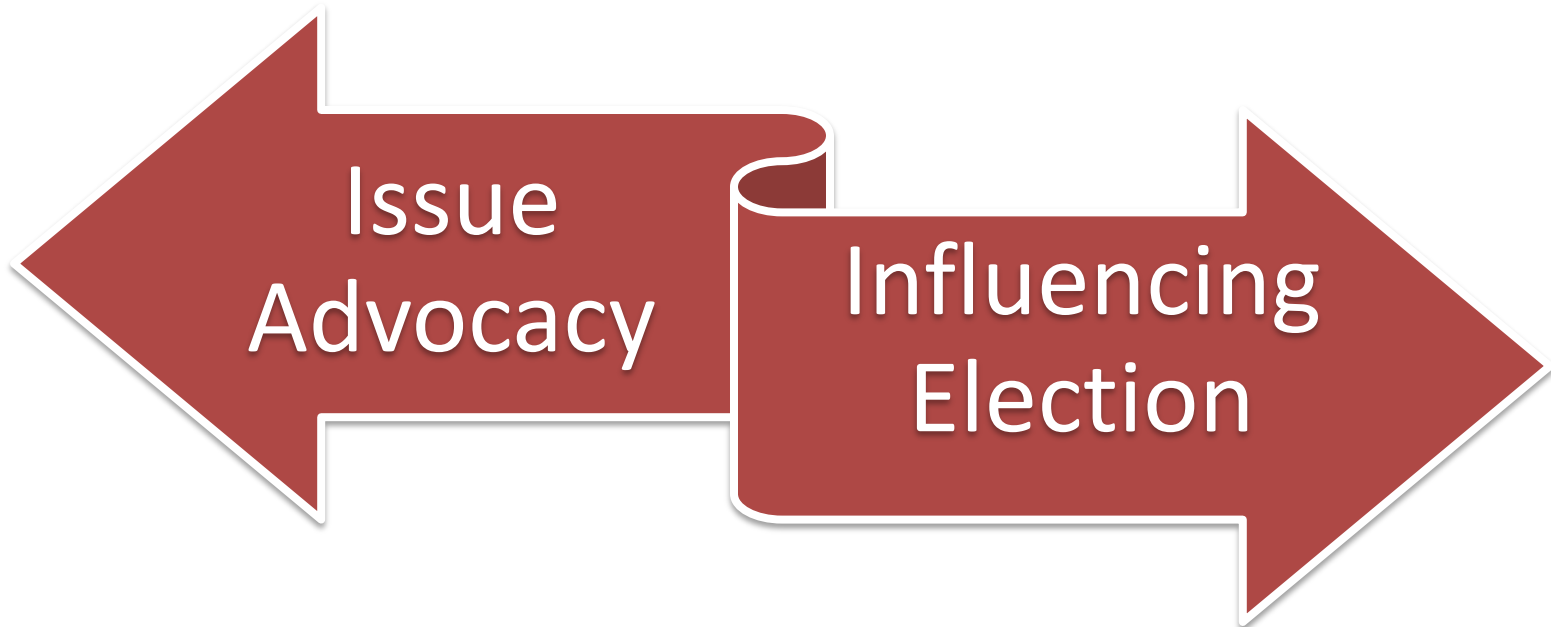

Learn More

Call Congress

Send to DC

Vote for X



Examples



Paid "volunteers"



Mail



Email



Television



Radio



Web/Social
Media



Calls



Regulatory Issues

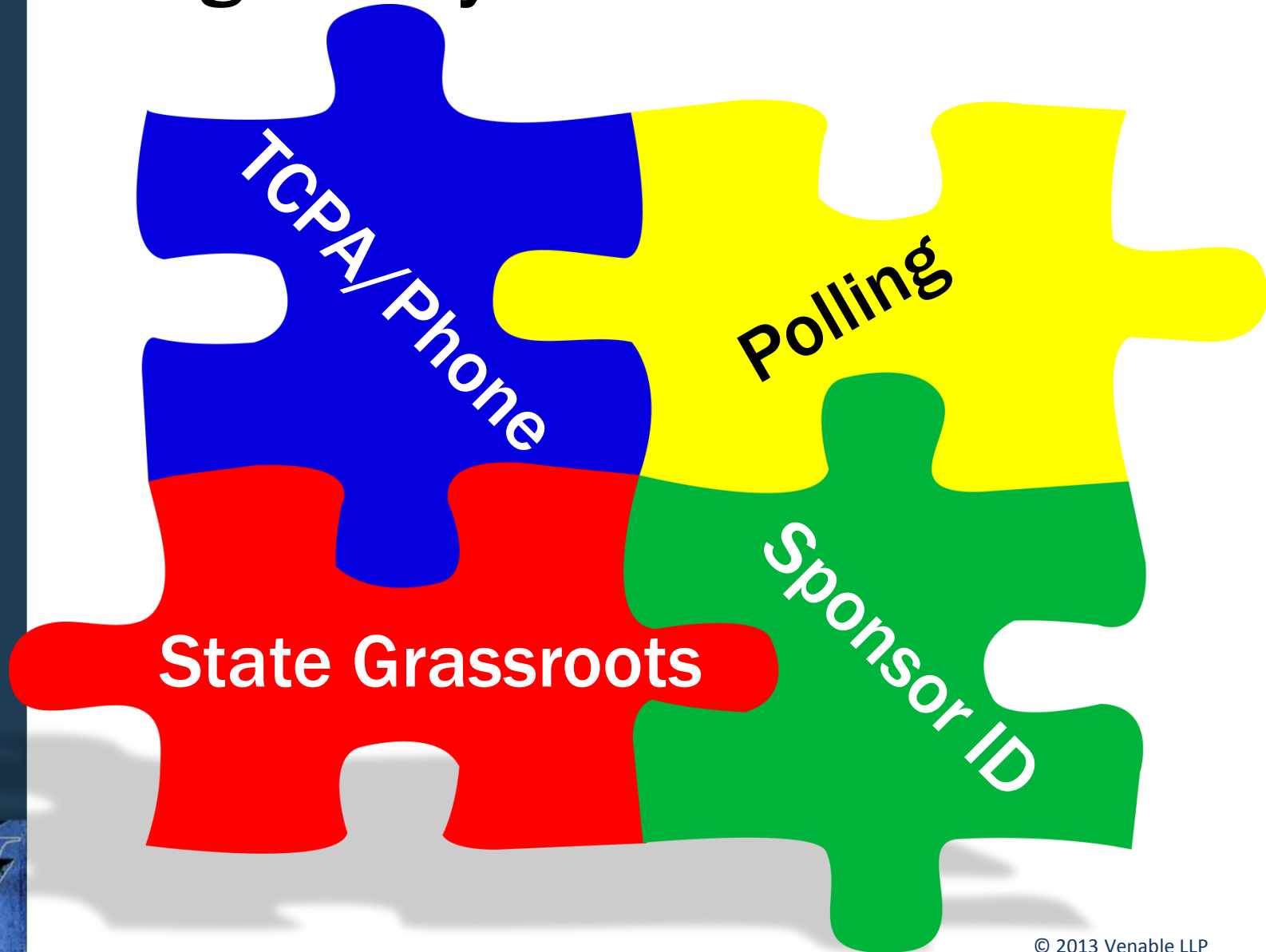

Grassroots Regulations

- **Some states require registration**
 - **Some tied to traditional lobbying**
 - **Others independent obligation**
- **Donor disclosure**
- **May not require call to action**



Types of Communications

Grassroots

Call to action

Any medium

Any time

Any organization
(limits on (c)(3))

Some state disclosure
possible

Issue Advocacy

Focuses on
issues/Does not
include CTA

Any medium

Any time
(but may become EC or
IE close to election)

Any organization

Some state disclosure
possible

Electioneering Communications

Refers to a clearly
identified candidate

Radio or TV
(state law varies)

Broadcast within 30 or
60 days of election

Any organization

Disclosed to FEC
(or state)

Independent Expenditures

Expressly advocating
the election or defeat
of a candidate

Any medium

Any time

Not (c)(3)
Limits on (c)(4) & (c)(6)

Disclosed to FEC
(or state)

Express Advocacy

Clear Words

Vote for

Elect

Defeat

Support

Facts &
Circumstances

Only be interpreted by a reasonable person as containing advocacy of the election or defeat of one or more clearly identified candidates

“Unmistakable” and
“unambiguous” “electoral
portion”



Independent Expenditure

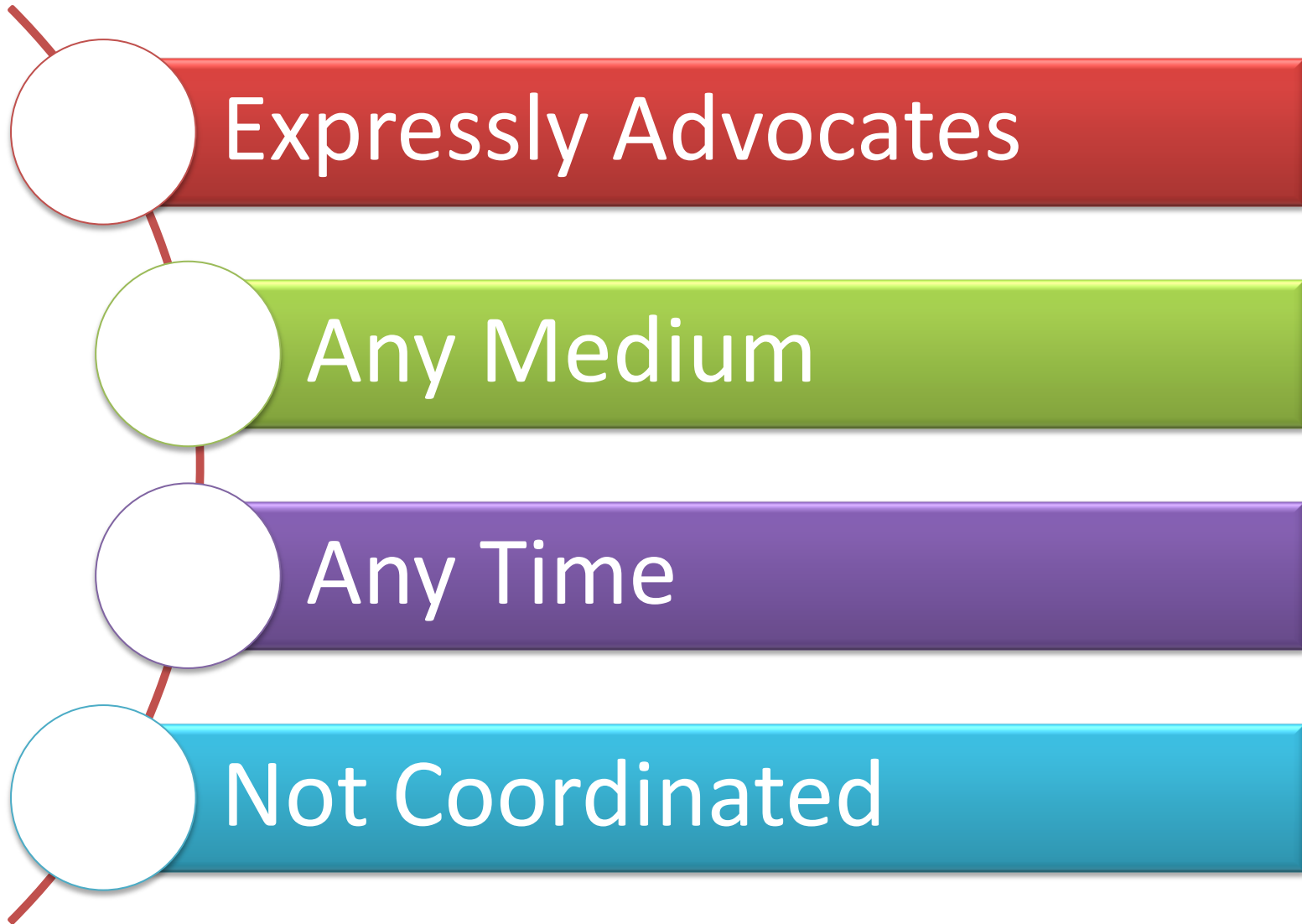

Coordination

In General

Request
or
Suggestion

Material
Involvement

Substantial
Discussion

Use of
Campaign
Material



Vendor/Employee

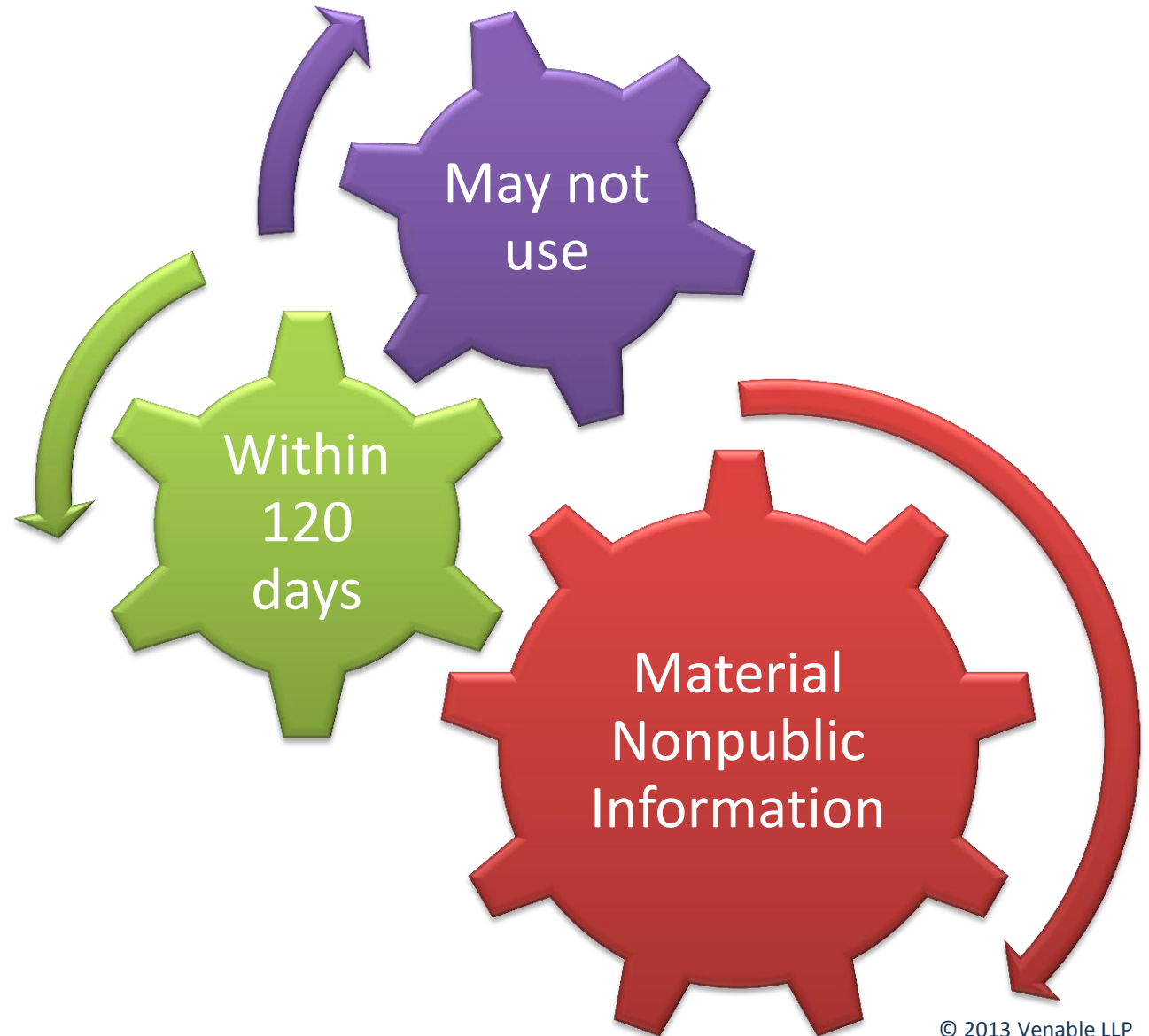

Trouble Areas for Nonprofits

- **Lobbying**
- **Contributions**
- **Member Communications**
- **Vendors**



Who can make IEs?

- **NOT 501(c)(3)**
- **501(c)(6)**
- **501(c)(4)**
- **Political Action Committees**
- **Super PACs**



What is a Super PAC?



Makes independent expenditures

Does not contribute to candidates

May not coordinate with candidates

Registered with FEC or state

Unlimited contributions



What about 501(c)(4) and (c)(6)s

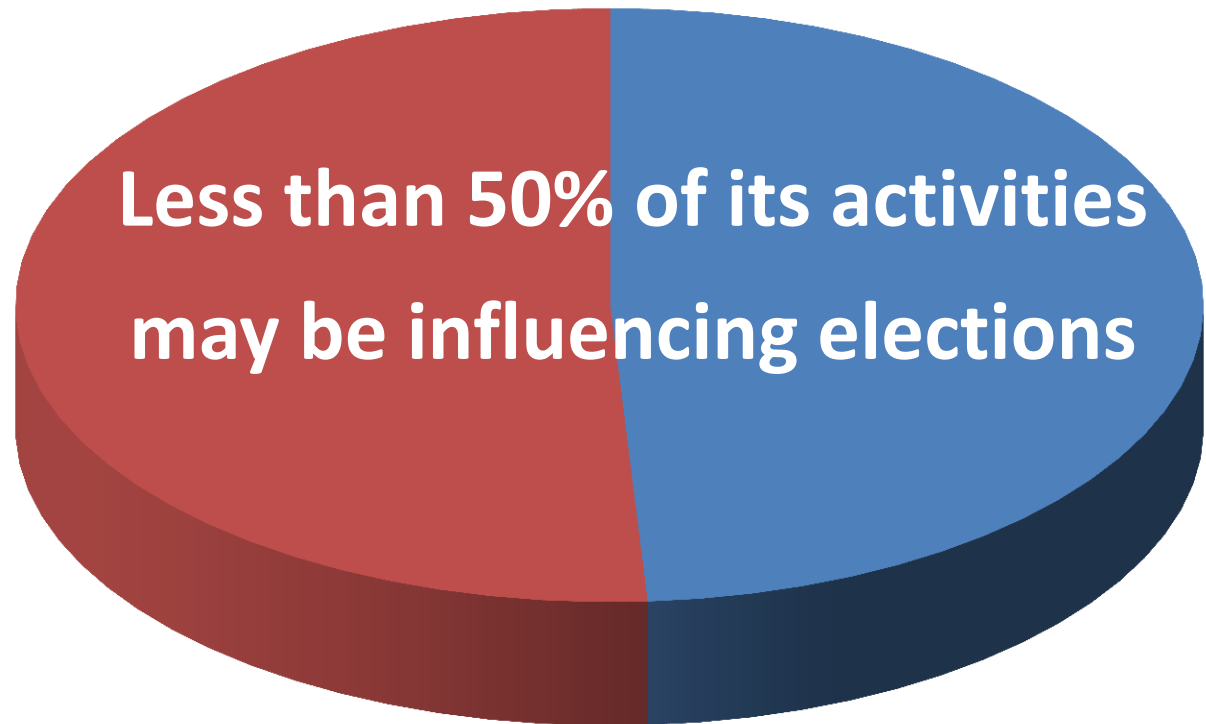

How to Be Active

- **Make IEs directly**
- **Fund a Super PAC**



Disclosure by Non-PACs

- **Disclose IE expenses**
- **Disclose contributors who made a donation in excess of \$200 to further the independent expenditure**



Funding a Federal Super PAC

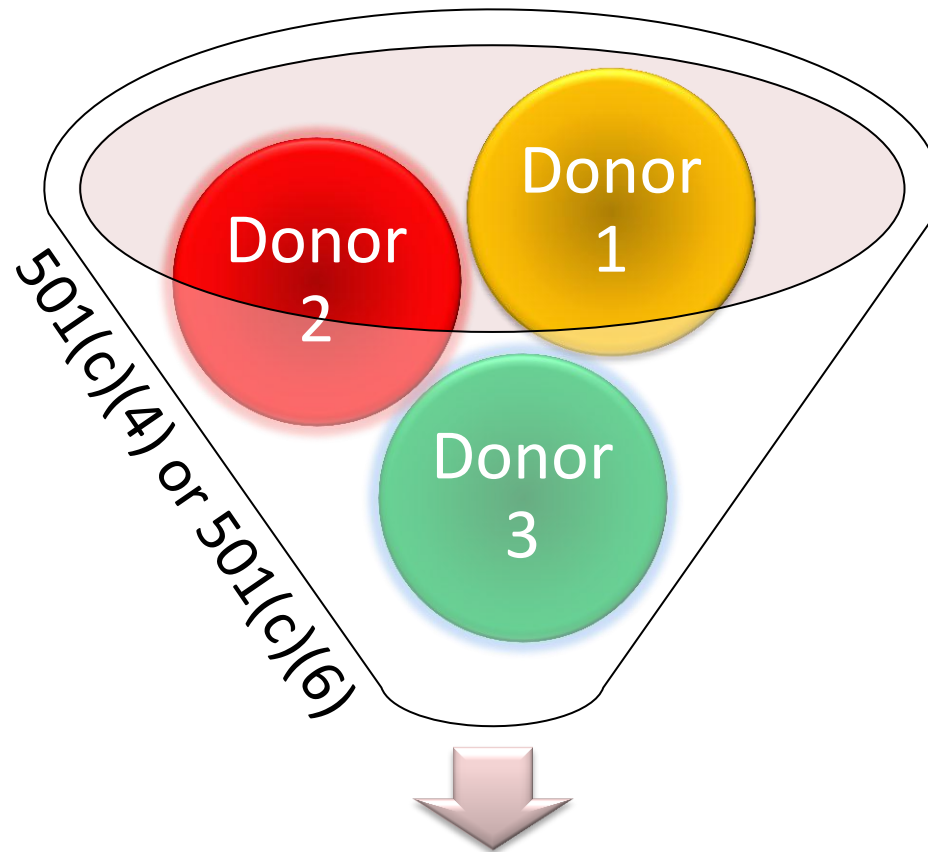

Entity Disclosed as Contributor by Super PAC



Super PACs in the States

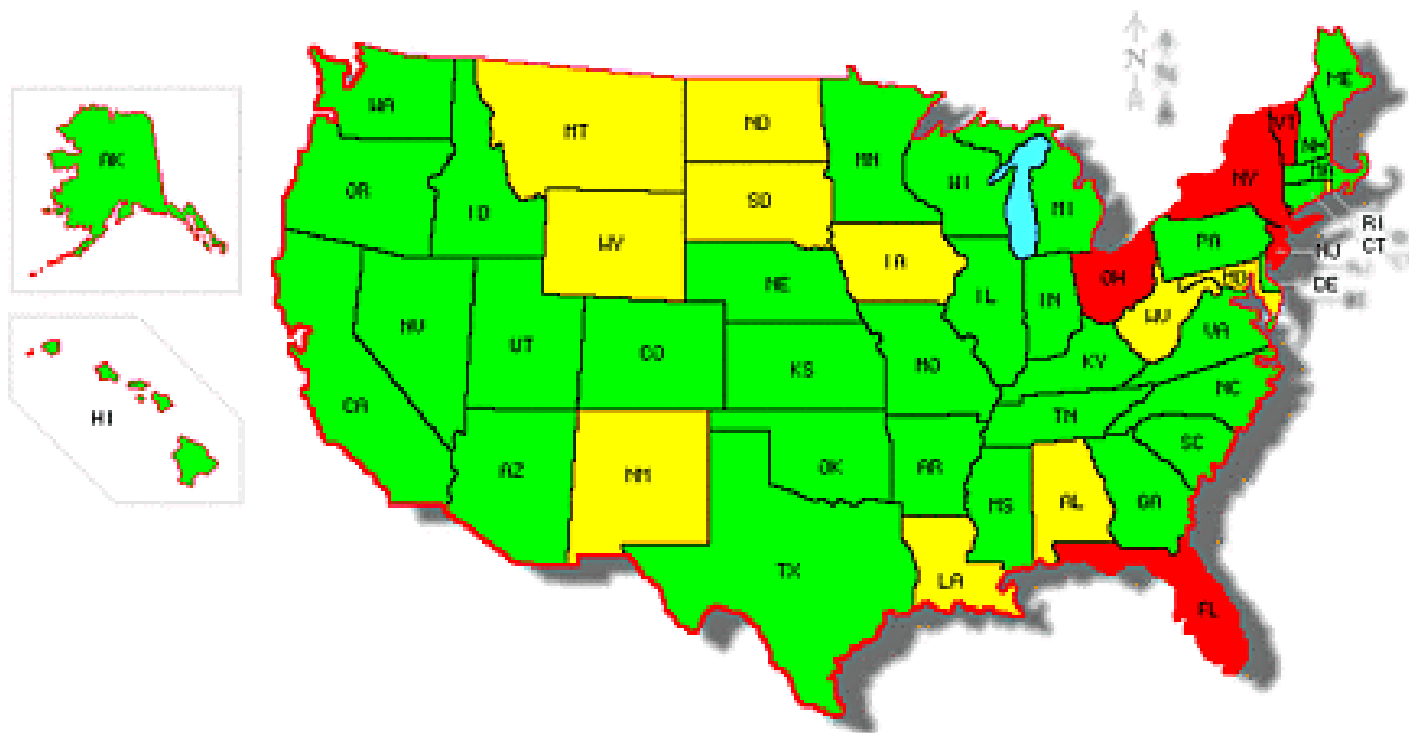

State Disclosure Issues

- **States are imposing additional disclosure obligations**
- **Investigations/Litigation**
 - **California**
 - **Montana**



Utah Requires Disclosure of Donors



Donor means a person that gives money, including a fee, due, or assessment for membership in the corporation, to a corporation without receiving full and adequate consideration for the money



A Thought

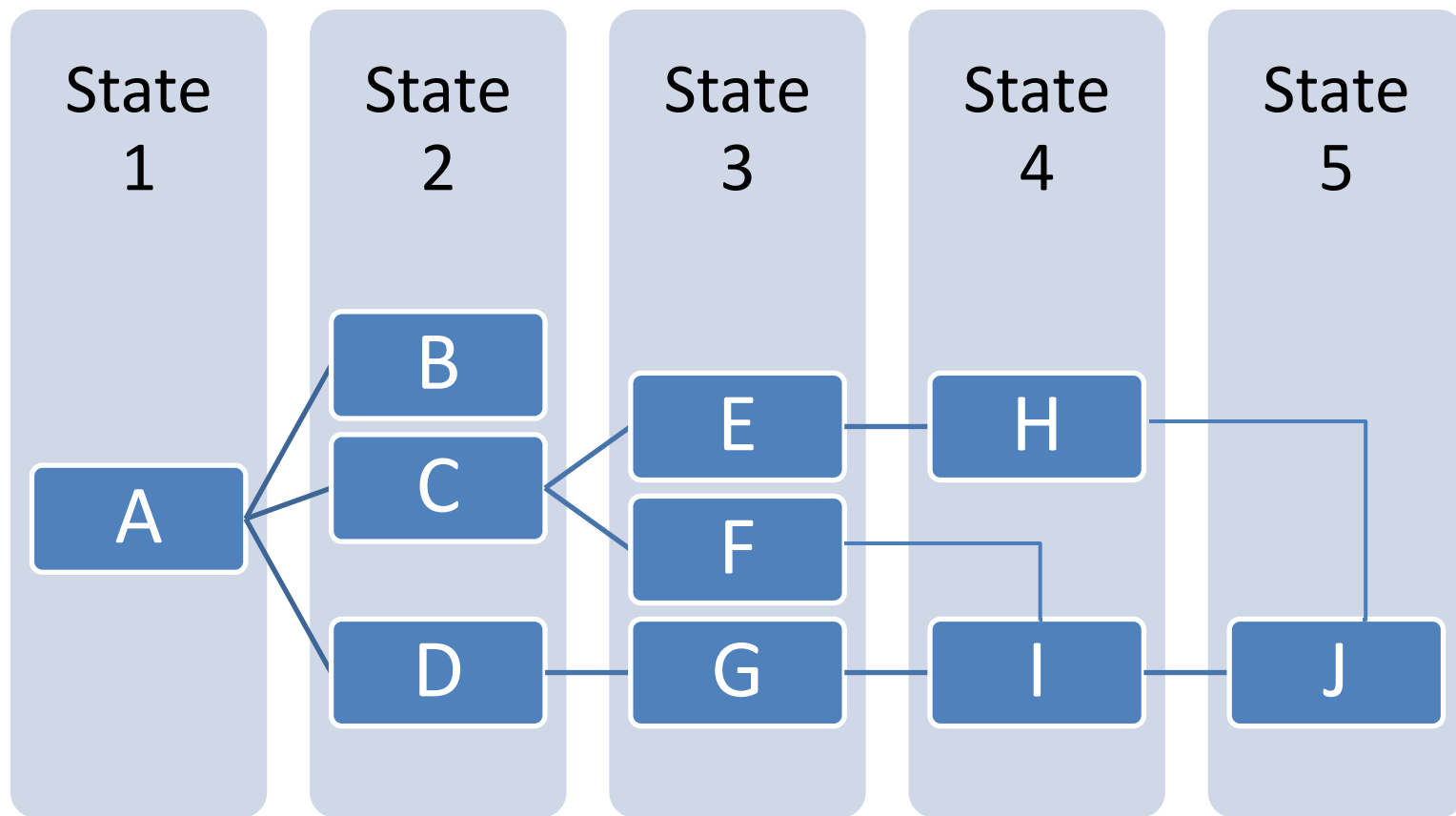

J discloses H and I
 I discloses G and F
 H discloses E



Tax Issues

- **Primary Purpose**
- **501(c)(4) Inquiries**
- **Congressional Inquiries**
- **Lack of clear guidance**



Satisfying the Primary Purpose

- ✓ **Don't rush to create a new entity**
- ✓ **Plan carefully**
- ✓ **Consider special purpose entities**



Solicitation Disclaimers

Required on fundraising appeals that clearly indicate funds will be targeted to the election or defeat of a candidate



Your Donors/Members

- **Shareholder efforts**
- **Corporate policies**
- **SEC possible rule**



VENABLE[®]_{LLP}

501(c)(3) Election Issues

501(c)(3)s



Candidate Appearances

- **Invite all candidates**
- **Equal opportunity to speak at similar events**
- **Explicitly state no support or opposition**
- **Tell people everyone was invited**
- **No fundraising**



Candidate Forums

- Invite everyone (or have objective criteria to limit)
- Equal opportunities to speak at similar events if not all together
- Note FEC rules on simultaneous participation



Candidate Appearances

- Questions prepared and presented by independent nonpartisan panel
- Topics cover broad range of issues
- Provide equal opportunity to respond/present views
- Don't use agree/disagree questions



Candidate Appearances



- Don't comment on questions
- Don't imply approval or disapproval
- No fundraising
- Maintain neutral atmosphere

Official Appearances

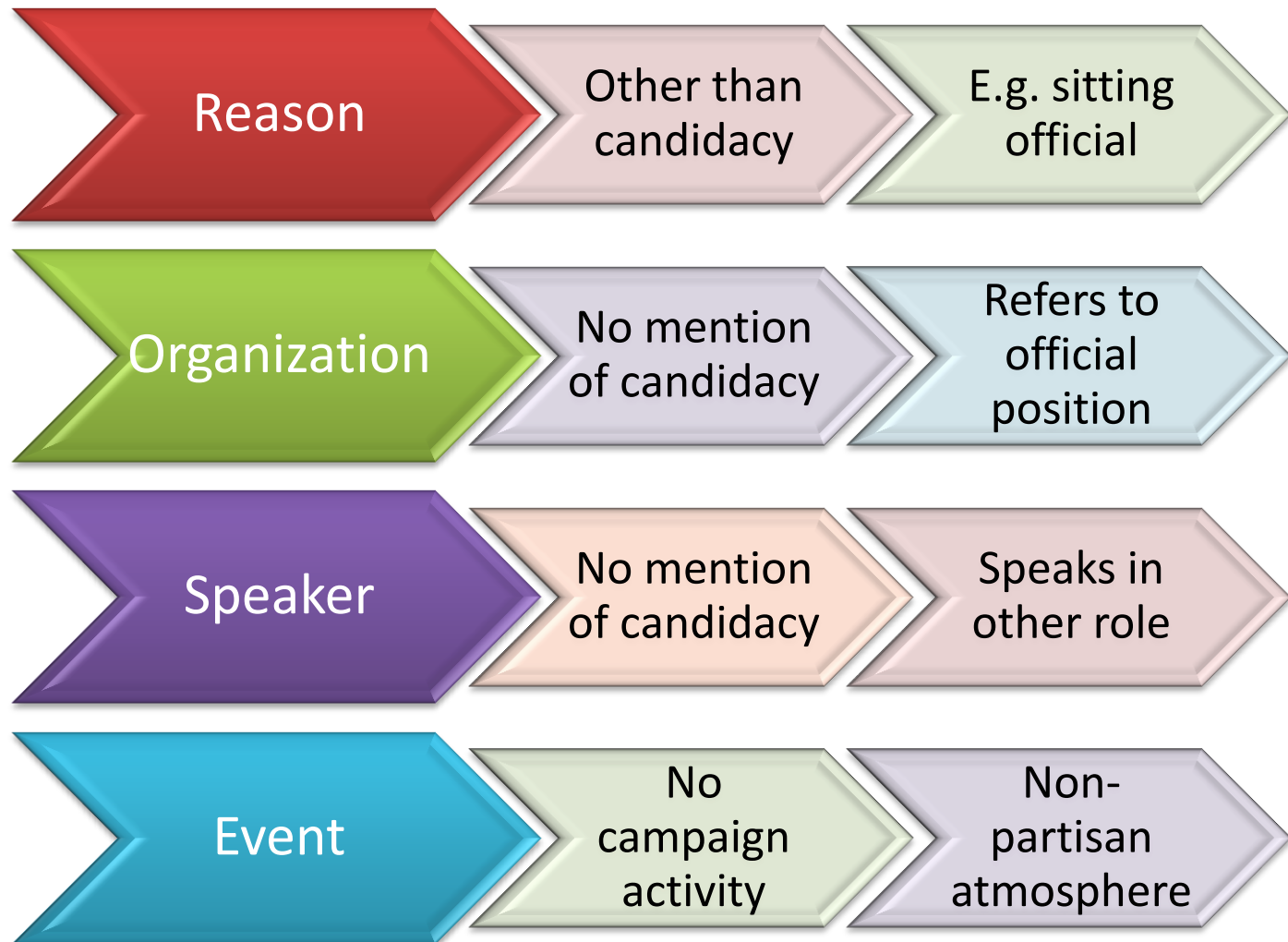

Legislative Scorecards

- **List all votes by a legislative body**
- **May include reference to issues**
- **May not include candidates**
- **Is it a regular activity**
- **Is it timed with an election**



Voter Guides/Questionnaires

Structure

All Candidates for office sent questionnaire

Unbiased structure

No endorsement

Questions

Clear and unbiased

Subjects cover major areas of interest

Clear issue descriptions

Don't ask to accept a pledge

Answers

Reasonable time to respond

If limited answers allowed (support/oppose), opportunity to explain position

Guides

Questions the same in the guide as provided to candidates

Answers the same as provided or edited for space only

Answers presented close to the question



Issue Advocacy

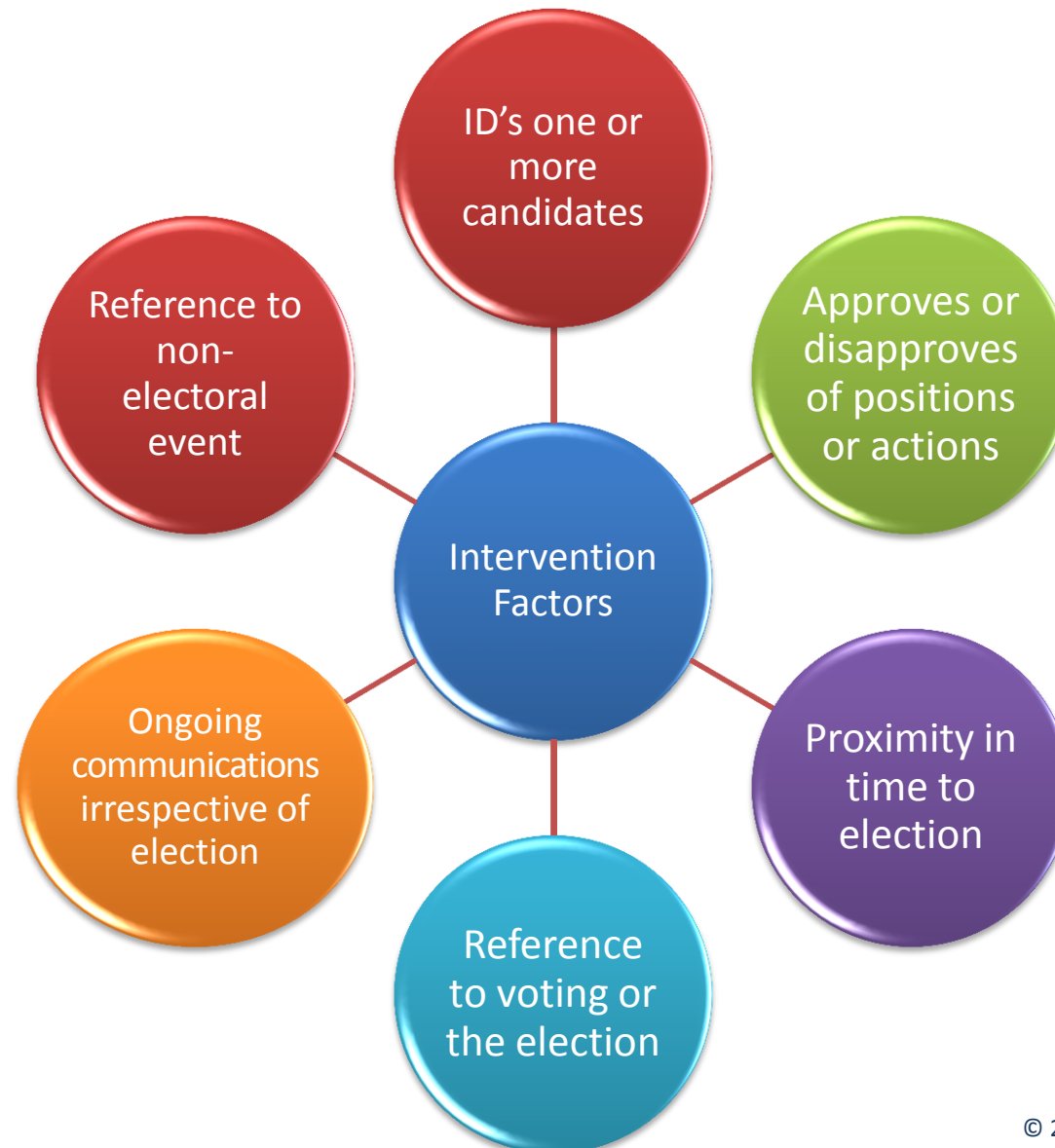

Staff/Leadership

- **Do not use organization resources**
- **“Identification only” use of name**
- **Disclaimer – “personal views”**



Staff/Leadership

- **Caution when working with 527s**
- **Caution with personal fundraising**



VENABLE[®]_{LLP}



Lobbying

Who is a federal lobbyist?

More than one lobbying contact

PLUS

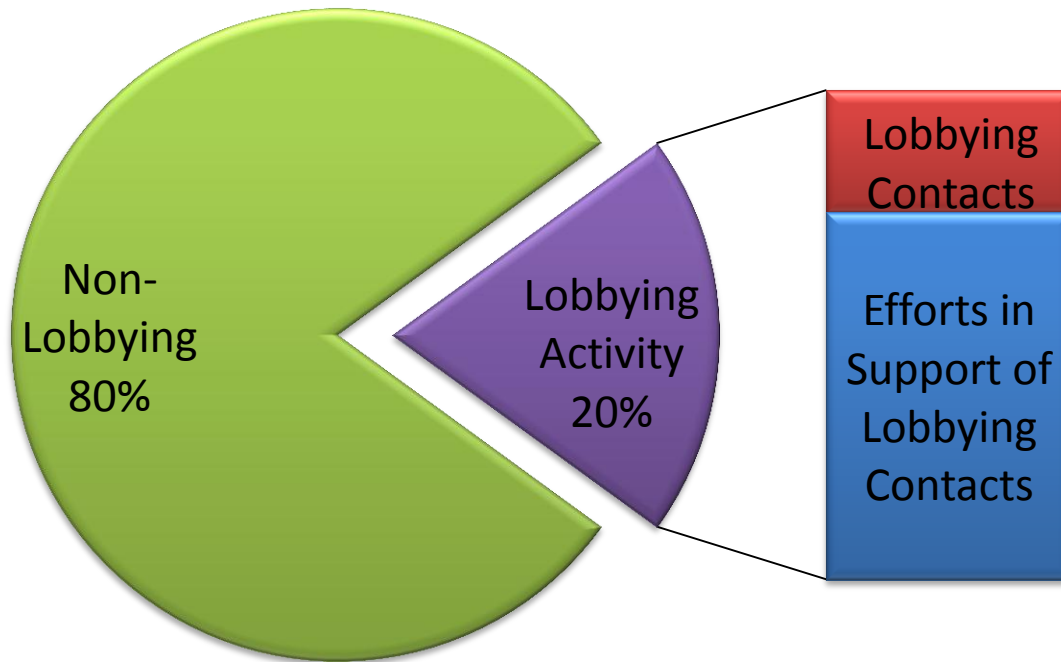

What is a lobbying contact?

Oral or written communication:

- Legislation
- Policy
- Contracts/Grants
- Nominations



Who is a covered official?

- Congress & Staff
- President & VP
- Executive Office of the President
- Executive Schedule 1-5
- Admirals and Generals
- Schedule C Appointees



What is lobbying activity?



Planning



Research



Coordinating

Quarterly Reports

- **Issues and agencies lobbied**
- **Amount spent on lobbying**
- **Names of lobbyists**
- **Publicly available**



Calculating Expenses

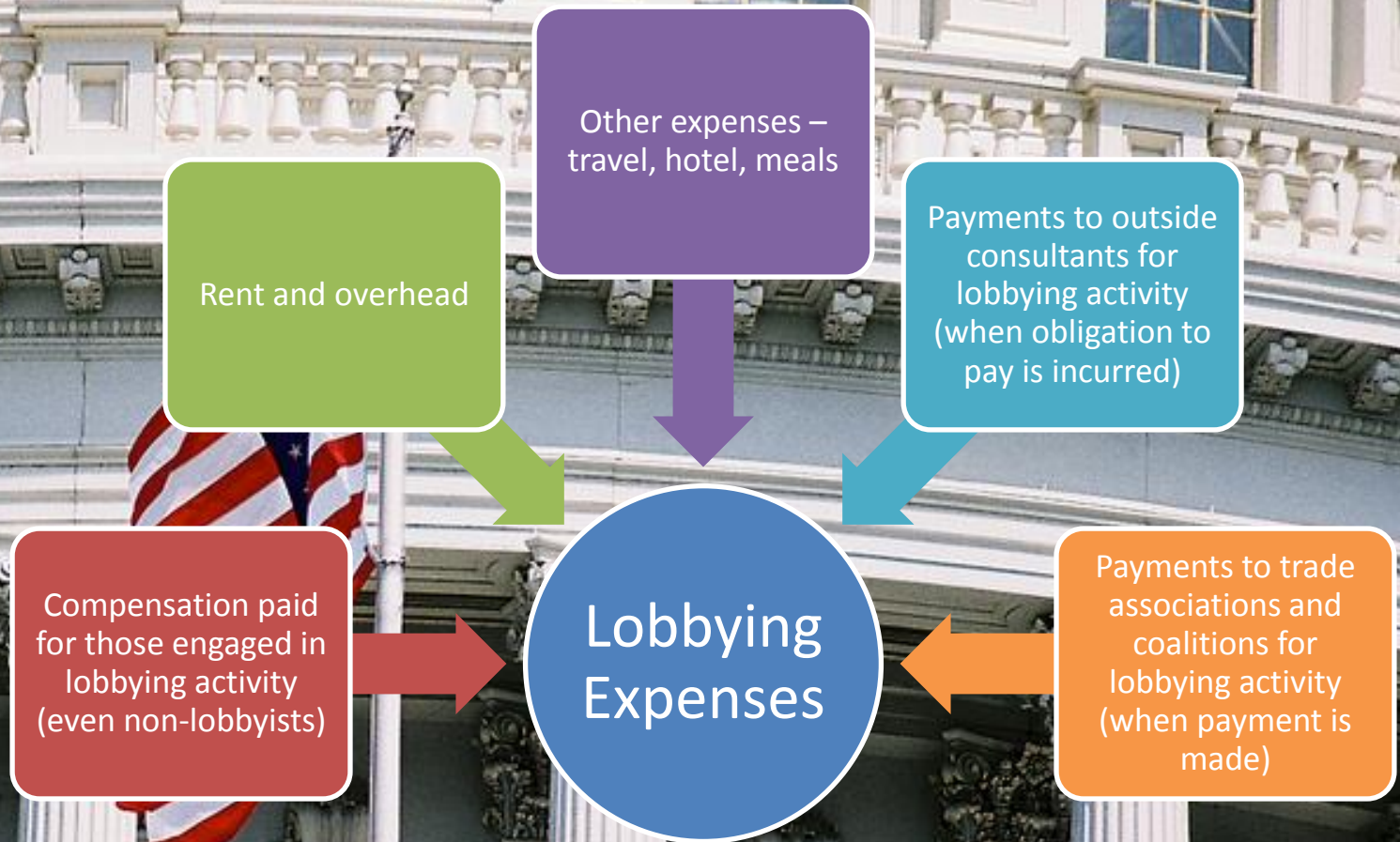

State Lobbying

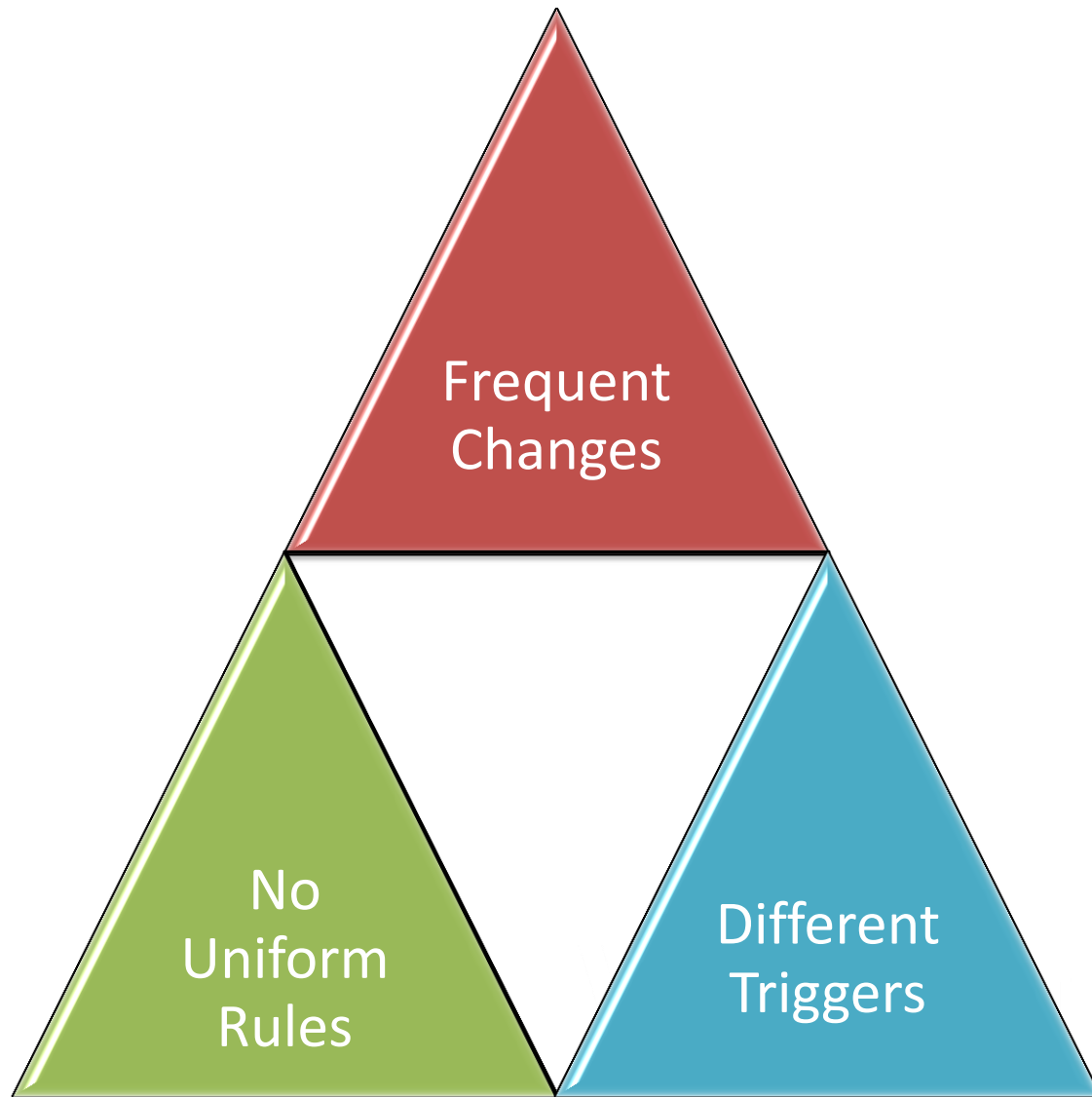

What is state lobbying?

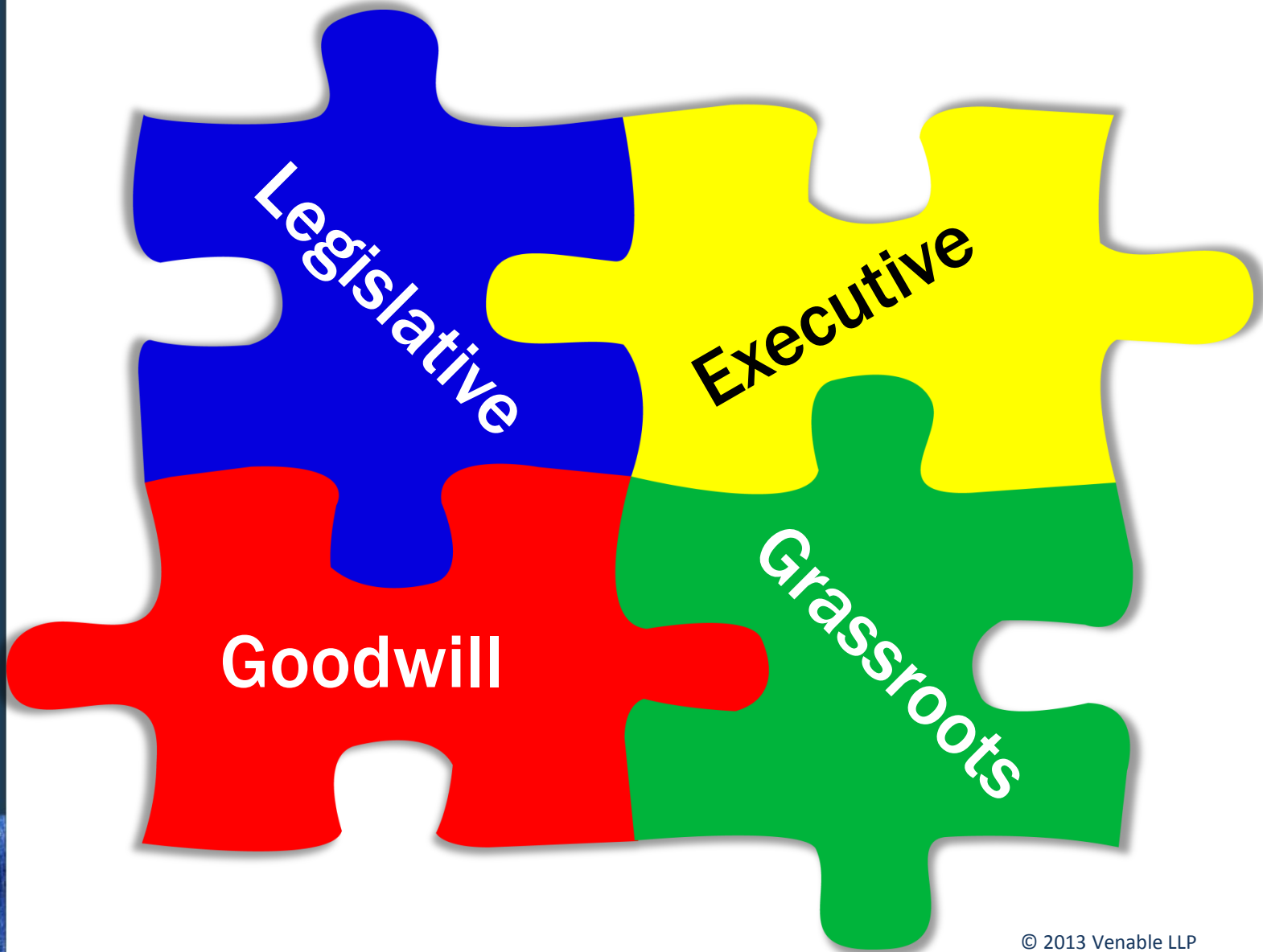

VENABLE[®]LLP

Tax Issues

162(e): Nondeductible Expenses

Notice to Members

Pay Proxy Tax



Different Definitions

Type of Lobbying

State

Grassroots

Legislative

Executive

International

LDA

No

No

Yes

Broad

No

162(e)

Yes

Yes

Yes

Narrow

Yes



LDA Options

Report using 162(e)

- One set of books
- Numbers may be “off”

Report using LDA

- Two sets of books
- More “accurate” numbers



501(c)(3) Limits on Lobbying

No Substantial Part

Facts and
Circumstances

501(h)
Election



Facts and Circumstances

- **Balance organization's activities in relation to its objectives and circumstances**
- **Attempting to influence legislation by propaganda or otherwise**
- **Proposing, supporting, or opposing legislation**



501(h) Expenditure Test

Influencing Legislation

Grass roots lobbying

- Any attempt to influence any legislation through an attempt to affect the opinions of the general public or any segment thereof; and

Direct lobbying

- Any attempt to influence any legislation through communication with any member or employee of a legislative body, or with any government official or employee who may participate in the formulation of the legislation.



Expenditure Limits

If the amount of exempt purpose expenditures is:	Lobbying nontaxable amount is:
≤ \$500,000	20% of the exempt purpose expenditures
>\$500,00 but ≤ \$1,000,000	\$100,000 plus 15% of excess of exempt purpose expenditures over \$500,000
> \$1,000,000 but ≤ \$1,500,000	\$175,000 plus 10% of excess of exempt purpose expenditures over \$1,000,000
>\$1,500,000	\$225,000 plus 5% of exempt purpose expenditures over \$1,500,000

Grassroots Limit: 25% of total lobbying limit



LDA Options

Report using 6033(b)(8)

- One set of books
- Numbers may be “off”

Report using LDA

- Two sets of books
- More “accurate” numbers



Private Foundations

- **May not lobby**
- **May not earmark grants for lobbying**
- **May provide technical assistance (with written request)**
- **May conduct nonpartisan analysis**



VENABLE[®]LLP

Common Gift Issues



Federal Gift Rules



Congress

- Registrant:
 - No, unless exception
- Lobbyist:
 - No, unless exception
- Others:
 - <\$50 or exception



Career

- Registrant:
 - \$20 or exception
- Lobbyist:
 - \$20 or exception
- Others:
 - \$20 or exception



Appointee

- Registrant:
 - No, unless exception
- Lobbyist:
 - No, unless exception
- Others:
 - \$20 or exception



Conference or Similar Event in DC

Invitee



Event

Speaker at the event
Determine that attendance is related to official duties

Speaker

In the interest of the agency; further agency programs and operations or speak at the event

Number of People

More than 25 non-Hill

No Specific Number



No Specific Number

Audience

Individuals from an industry or profession or represent a wide range of persons interested in a given matter

Diversity of views or interests will be present

Diversity of views or interests will be present

Invitee	Type of Event	Purpose	Timing	Lobbyist	Process
 <p>Congressional</p>	<p>Meeting, conference, speech, award, fact-finding</p>	<p>Officially connected</p>	<p>1 night if LDA registrant (2 for long trips)</p>	<p>Minimal involvement</p>	<p>Submit approval before trip</p>
 <p>Executive Branch</p>	<p>Meeting, conference, speech, panel, training, award</p>	<p>In the interest of the government</p>			<p>No limits</p>
		<p>No question of government integrity</p>			

Receptions

CONGRESS

- Hors d'oeuvres & beverages
- Coffee & bagels
- No sit-down meal
- No one-on-one

EXEC BRANCH

- \$20 per person/\$50 per year
- Coffee, donuts, etc.
- Often have to pay to attend

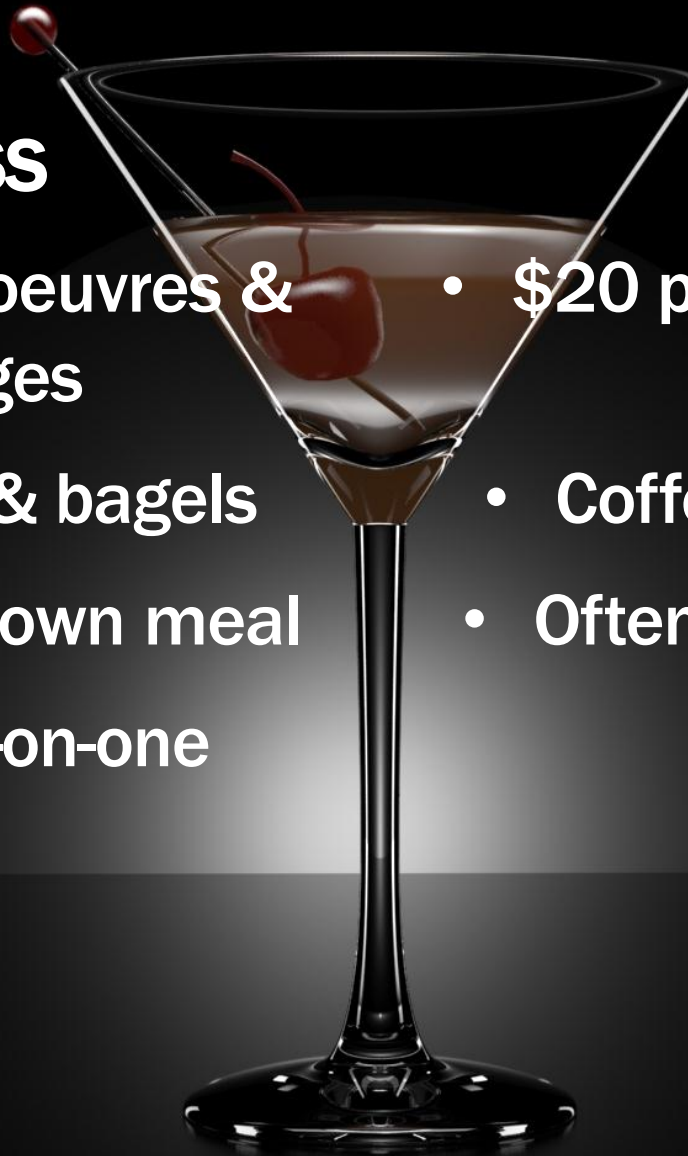

Educational Briefings

- **May not be a lobbying or advocacy group**
- **Universities, think tanks, foundations, etc.**
 - **May not be used for legislative briefings**
- **Otherwise might fit widely attended (25 non-Hill people)**



Charity Events

- **House & Senate**
 - Charitable fundraiser
 - Not just “congratulatory” celebration
- **Executive**
 - No special rule, look to widely attended
- **Invitations**
 - House: allows for suggestions; no direct contact
 - Senate: harder line

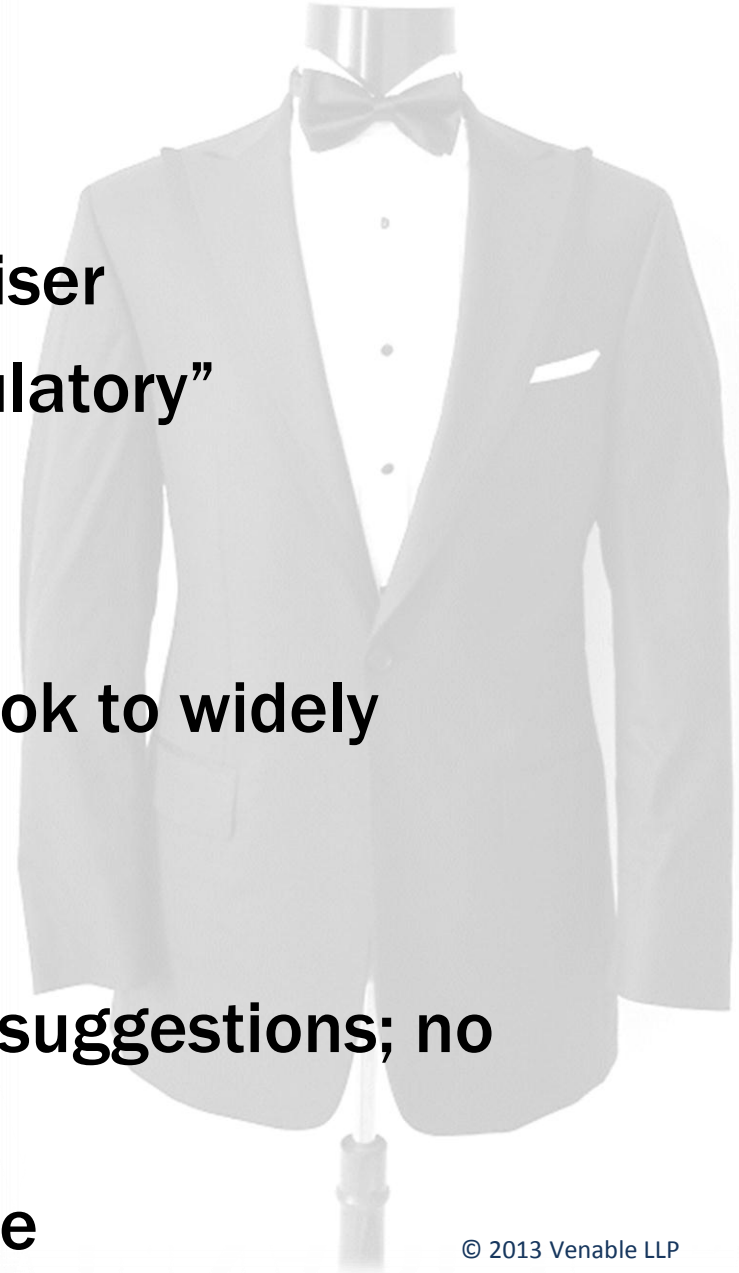

VENABLE[®]_{LLP}

Putting It All Together



Risk Management

- Use simple and clear policies and procedures
- Track time on activities that support lobbying
- Keep records that substantiate your due diligence
- Obtain pre-approval of gifts
- Don't forget consultants



Final Thoughts

- Heavily regulated area, with many traps for the unwary
- Ask first!
- Usually a way to accomplish your goals
- Regardless of the rules, always consider the *Washington Post* test



Questions?

Jeff Tenenbaum, Esq.

jstenenbaum@Venable.com

t 202.344.8138

Larry Norton, Esq.

lnorton@Venable.com

t 202.344.4541

Ron Jacobs, Esq.

rmjacobs@Venable.com

t 202.344.8215

Janice Ryan, Esq.

jmryan@Venable.com

202.344.4093



For additional information

On Nonprofits:

To view Venable's index of articles, PowerPoint presentations, recordings and upcoming seminars on nonprofit legal topics, see www.Venable.com/nonprofits/publications, www.Venable.com/nonprofits/recordings, www.Venable.com/nonprofits/events.

On Political Law:

For more information on Venable's Political Law Practice, see www.Venable.com/political-law-practices or for frequent updates on political law topics, visit www.PoliticalLawBriefing.com or [click here](#) to subscribe to the blog.

